

## Pro-Spray®

*Rugged, Long-Lasting, Contractor-Friendly Sprays  
for Residential and Commercial Projects*

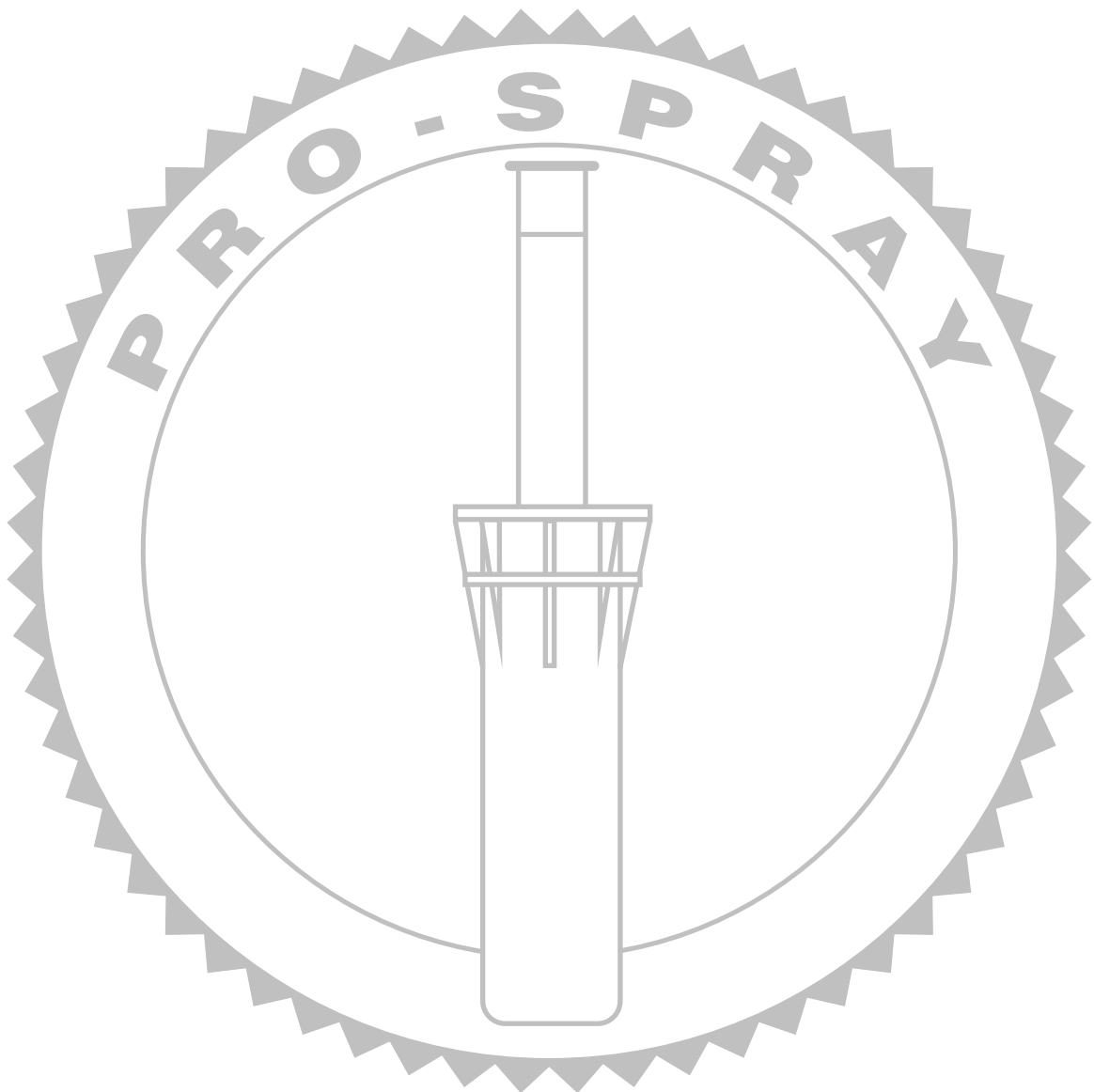

## TABLE OF CONTENTS

### **Pro-Spray®**

Product Overview .....	1
Product Features and Benefits .....	2
Product Comparisons.....	5
Installation Details .....	6
Technical Information.....	7

### **Spray Nozzles**

Product Overview .....	8
Product Features and Benefits .....	9
Product Performance .....	11
Product Comparisons.....	15
Installation and Maintenance .....	15

### **Bubbler Nozzles**

Product Features and Benefits .....	16
-------------------------------------	----

### **Formulas**

Precipitation Rate Formula .....	17
Sprinkler Run Time Formula .....	17

---

## PRODUCT OVERVIEW

### *Rugged, Contractor-Friendly Spray Heads for Residential and Commercial Projects*

Hunter has created a spray type sprinkler rugged enough to stand up to the needs of a professional contractor. The Pro-Spray®.

Designed for a long life of reliable operation, the Hunter Pro-Spray has been manufactured with the precision required to ensure peak performance for years to come. This solid performer boasts heavy-duty ABS construction, including an extra-thick body and cap previously unheard of in a Hunter spray. A heavy-duty spring promises positive retraction under the toughest conditions. Exclusive body ribs make the Pro-Spray easier to install, adjust, and service while also providing more stability for the sprinkler in loose soils.

But brawn isn't all this product offers. The Pro-Spray also features a user-friendly "pull-up" flush cap that makes installation quicker and easier, and helps keep debris to a minimum. There's also a pressure activated, multi-function wiper seal that eliminates flow-by and allows more sprinklers to be installed on the same zone. Plus, an optional drain check valve for up to 10 feet of elevation change that eliminates landscape damage from flooding and erosion. Add in the Pro-Spray's compatibility with all industry standard female nozzles—as well as Hunter's own complete line-up of adjustable, fixed and specialty nozzles—and you have the industry's most versatile spray sprinkler.

The Hunter Pro-Spray. A spray sprinkler designed with the professional in mind.

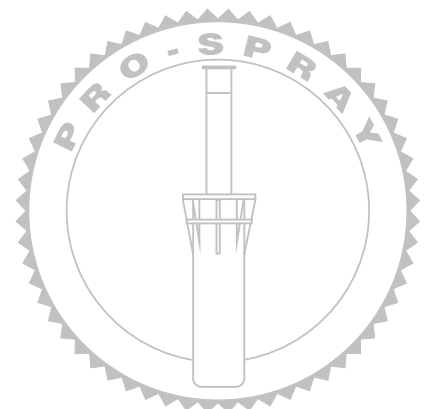

## PRODUCT FEATURES AND BENEFITS

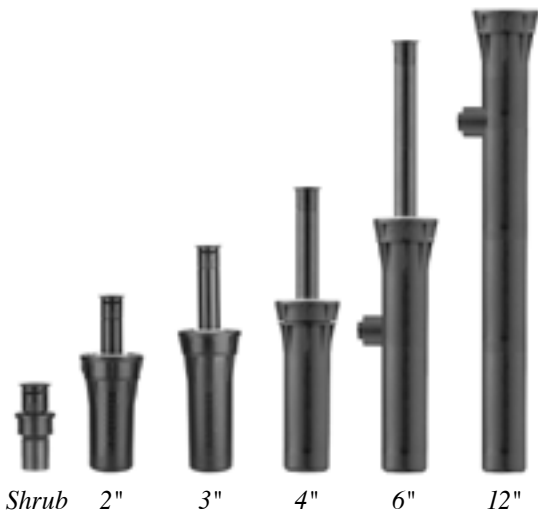

### **Anti-drain Check Valve...**

*Elevation changes are no longer an issue*

The Pro-Spray® family anti-drain check valve, which is factory installed or available as an optional part, will hold back 10' of elevation change. When a Pro-Spray body is ordered with the check valve pre-installed from the factory, the words CHECK VALVE are stamped in white lettering on the cap to aid in spray head identification.

This Hunter check valve is unique in this class of spray heads because it may also be field installed after head installation. Contractors or irrigation maintenance personnel will appreciate the fact that if the Pro-Spray is installed without a check valve, but is found to require one at a later date, it can be easily added into the bottom of the riser assembly.

A significant advantage of a spray head check valve is its ability to trap water in the system piping. This substantially reduces wear on system components by minimizing surges (water hammer) when the valve opens. Also, by stopping low head drainage, the Pro-Spray check valve will put an end to landscape damage caused by flooding and erosion.

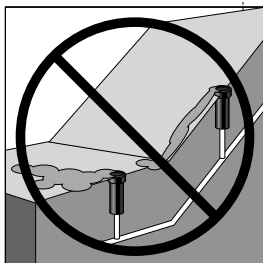

*No wasteful low-head drainage*

### **Heavy-Duty Body Construction...**

*Robust design stands up to the competition*

The Pro-Spray body has been designed to withstand the harshest environments. The material used to construct the body and cap is super tough ABS plastic that has been molded with dimensions that furnish the high-pressure ratings given to this sprinkler. A multi-thread buttress design is used on the cap (because of its superior strength in cap-to-body gripping capacity) making the head very robust when it comes to withstanding high inlet surge pressures. Also contributing



*Heavy duty ribbing*

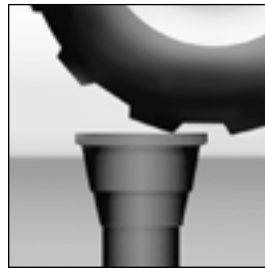

*Stands up to heavy equipment*

to its outstanding ruggedness, external ribbing is molded into both the body and cap to strengthen the unit against heavy traffic such as riding lawnmowers or other heavy equipment.

### **Heavy-Duty Spring...**

*Positive retraction under any conditions*

With its heavy-duty, high-grade stainless steel spring, the Pro-Spray provides dependable stem retraction time after time. The spring and multi-function wiper seal work together to assure no more "stick-ups" in harsh environments, eliminating the least effective use of contractors time: the callback. The Pro-Spray spring retraction force is much more powerful than its closest competitor, one of the leading spray heads in the industry.



### ***Ratcheting Riser...*** ***Quick arc alignment***

Turning the riser stem on the Pro-Spray by “ratcheting” will quickly and easily align the spray pattern to the correct position. This adjustment can be made while the sprinkler is operating, allowing one to align the spray pattern within the proper boundaries as required.

The Pro-Spray’s ratcheting system is an integral part of the body and riser stem. This integration aids in making it a very sturdy and robust ratchet system.

The body of the Pro-Spray also works in conjunction with the ratcheting riser stem by providing six internal ribs which substantially increase the stability of the ratcheting system. With six ribs in the body, riser “walk” (the ‘twisting’ tendency of the riser, induced by the up and down action of the retract spring) is eliminated.

### ***Multi-function Wiper Seal...*** ***Water efficient and long life***

The Pro-Spray comes with a heavy-duty pressure-activated multi-function wiper seal which has been treated with UV inhibitors to insure long life when constantly exposed to the sun’s rays. The flow-by is 0 GPM at 10 PSI or greater and only 0.1 GPM otherwise. This no flow-by allows installers to add more heads on the same valve.

The additional wiper seal support in the Pro-Spray helps to ensure strength and reliable performance of the wiper seal under higher pressures. Plus, in the field, the wiper seal can be easily

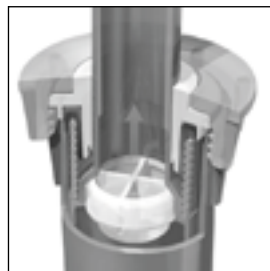

*Seal grips riser at top and bottom—eliminating wasteful flow-by*



CAP

CO-MOLDED WIPER SEAL

removed from the cap. This permits easy cleaning or replacement and keeps the benefits of no flow-by during operation as well as a positive retraction every time.

### ***Compatible with All Female-Threaded Nozzles...*** ***Accepts all major brands***

The Pro-Spray is fully compatible with all the popular female-threaded nozzles in the industry widely inventoried by contractors. In addition, Hunter’s complete line of compatible nozzles, including the



*Standard female thread nozzles*

adjustable and fixed arcs as well as specialty units such as the Micro-Spray or PCN Bubbler nozzle, are available for a total installation. Now installers can irrigate any landscaped area with the Hunter spray head line.

### ***Handy Flush Plug...*** ***Makes flushing and nozzle installation fast and easy***

The Hunter Flush Plug is a new innovative design that positively keeps muddy water and debris from entering back into the spray head after flushing is complete. It is designed to open as the stem extends upward and completely close when the stem is in the retracted position.

## PRODUCT FEATURES AND BENEFITS *(continued)*

The flush plug allows the flushed water to escape only in one direction, which is ideal when trying to keep water off of buildings, cars and sidewalks. It also allows only a limited amount



*Directional flushing action*

of water flow to pass through it, permitting a controlled directional flushing. This limited flow allows the riser assembly to fully pop up during system flushing for maximum flushing



*Handy pull-ring flush cap*

action. Another convenient feature installers will benefit from is a pull ring that allows for effortless pull up of the riser stem, making installation of nozzles easier and quicker.

### **Standard Side Inlet...**

*Installation convenience for deep-seated bodies*

The 6 and 12-inch models come with a standard ½" side-inlet for installation in shallow depth trenches making retrofits or new installations easy to accomplish. The side plug is removable and placed in the bottom inlet for quick versatility in challenging sites.



*Side inlet reduces digging*

### **Optional Black Rubber Cap Cover...**

*Ideal for high traffic and play areas*

Now, all your Hunter sprinklers on the project can provide a degree of protection in high traffic or play areas when the spray head rubber cover is used on the Pro-Spray®. This rubber cover serves the same function as the rubber cover on the rotors. An important feature to those who come in contact with the top of the sprinkler in an abrupt manner. This black spray head rubber cover is field-installable and may be ordered using P/N 469805.

### **Reclaimed Water I.D...**

*Options for effluent water use*

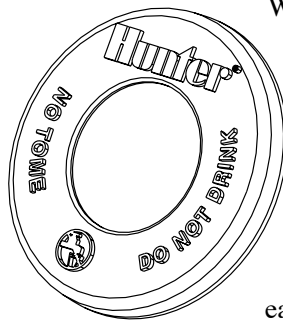

Watering with reclaimed water? Ask for the field-installable purple Hunter spray head body cap (P/N 458520) for permanent and confident identification. The cap can easily be screwed onto

Pro-Spray bodies before installation. Or ask for the field-installable purple Hunter spray head cap cover (P/N 469800) for quick and confident identification. The cover can easily be snapped on to Pro-Spray body caps either before or after installation.



### **Date Coding...**

*Identify exactly when the spray head was manufactured*

Hunter spray heads including the Pro-Spray have the manufactured date code molded on the top of the cap near the wiper seal. The date is molded as a 4-digit code, the first two digits representing the quarter, the last two digits indicating the year (e.g., 02 05 stands for 2nd Quarter 2005).

## PRODUCT COMPARISONS

FEATURES	Hunter® Pro-Spray®	Hunter® Pro-Spray® CHECK	Rain Bird® 1800	Rain Bird® 1800-SAM	Toro® 570Z	Toro® 570Z COM
Optional "field installed" drain check valve	✓	included				
Check valve controls a min. of 10' of elevation change	option	✓	N/A	✓	N/A	✓
Heavy-duty external ribs on body and cap	✓	✓				
Ratcheting riser	✓	✓	✓	✓	✓	✓
No flow-by wiper seal at 10 PSI	✓	✓	✓	✓	✓	✓
Serviceable wiper seal	✓	✓			✓	✓
Accepts industry standard female threads	✓	✓	✓	✓		
Positively self-sealing flush plug	✓	✓				
Directional flow flush plug	✓	✓				
Standard side-inlet on 6" and 12"	✓	✓	✓	✓	option	
Optional reclaimed water identification body cap	✓	✓				
Optional rubber cover	✓	✓				

### MODELS

PROS-00 – Shrub  
 PROS-02 – 2" Pop-up (5 cm)  
 PROS-03 – 3" Pop-up (7.5 cm)  
 PROS-04 – 4" Pop-up (10 cm)  
 PROS-06 – 6" Pop-up (15 cm)  
 PROS-12 – 12" Pop-up (30 cm)

### DIMENSIONS

- Overall height:
  - PROS-00 – 7/8" (2 cm)
  - PROS-02 – 4" (10 cm)
  - PROS-03 – 5" (12.5 cm)
  - PROS-04 – 5 7/8" (15.5 cm)
  - PROS-06 – 8 3/4" (22.5 cm)
  - PROS-12 – 16 1/8" (41 cm)
- 1/2" female inlet NPT
- Exposed diameter: 2 1/4" (6 cm)

### OPERATING SPECIFICATIONS

- Pressure range: 15 to 70 PSI (1.0 to 4.8 bars; 103 to 482 kPa)
- Flow-by: 0 at 10 PSI (.07 bars; 68 kPa) or greater; 0.1 GPM (0.02 m³/hr; 0.4 l/min) otherwise
- Precipitation rates: approximately 1.5" (38 mm) per hour using Hunter nozzles

### OPTIONS AVAILABLE

- Optional field-installed drain check valve for up to 10' (3.0 m) elevation change. P/N 437400
- Optional field-installed reclaimed water identification body cap. P/N 458520
- Optional field-installed black rubber cover. P/N 469805
- Optional field-installed reclaimed water identification cover. P/N 469800

### SPECIFICATION GUIDE

EXAMPLE: **PROS - 04 - CV - 15H**

MODEL	POP-UP HEIGHT	OPTIONS	NOZZLE SERIES	PATTERN
PROS = Pro-Spray	00 = Shrub 02 = 2" Pop-up 03 = 3" Pop-up 04 = 4" Pop-up 06 = 6" Pop-up 12 = 12" Pop-up	CV = Factory-Installed Drain Check Valve (Pop-up Models Only) CV-R = Factory-Installed Reclaimed Body Cap	8 = 8 Series 10 = 10 Series 12 = 12 Series 15 = 15 Series 17 = 17 Series*	A = Adjustable Q = Quarter-Circle H = Half-Circle F = Full-Circle

**Note:** Bodies and nozzles sold separately. Also compatible with Hunter's bubbler and specialty nozzles.  
 \* 17 Series available in Adjustable, Half, and Quarter-Circle patterns only. CV and CV-R models not available in 2" or 3" pop-ups.

## INSTALLATION DETAILS

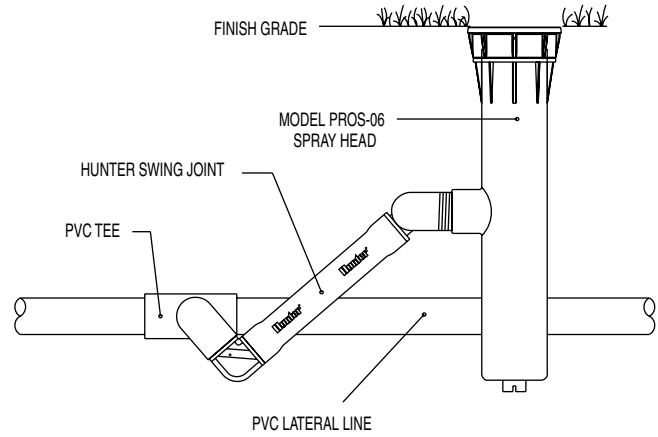
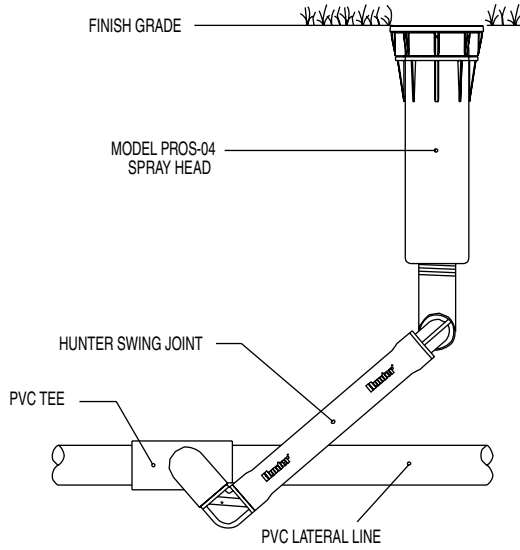

**Hunter® PROS-04**

**Hunter® PROS-06**

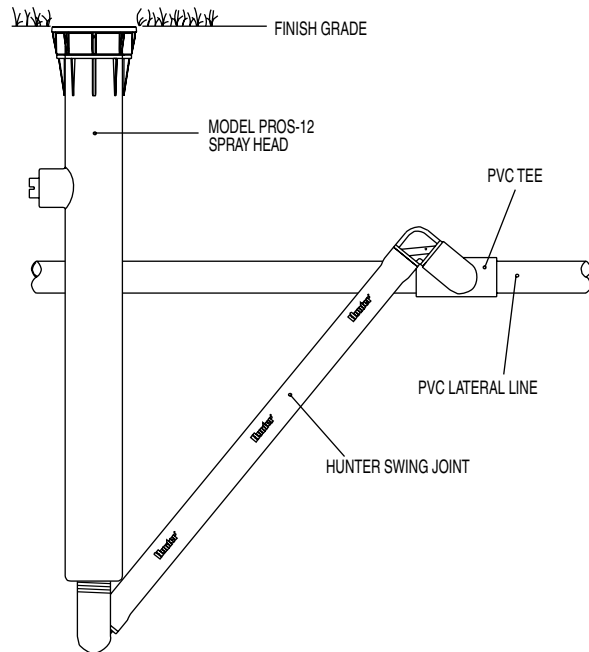
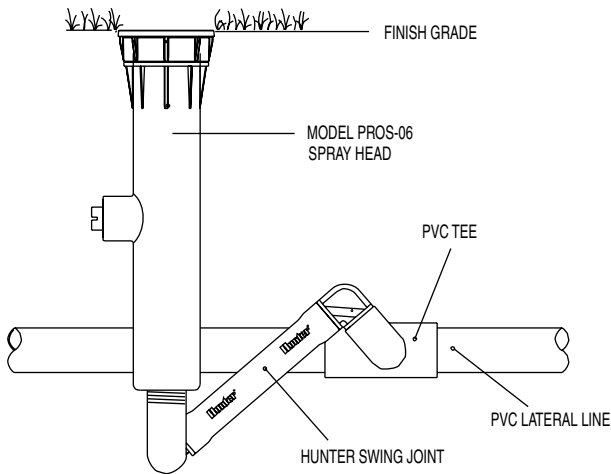

**Hunter® PROS-06**

**Hunter® PROS-12**



## PROS-04, 06, 12: REPLACEMENT PARTS

Item	Description	Catalog No.	
①	Flush Cap ( <i>Gray</i> )	423900	
②	Snap-On RubberCover	Black	469805
		Purple	469800
③	Body Cap	Standard (Black)	458500
		With Check Valve ID (Black)	458505
		Reclaimed Body Cap (Purple)	458520
		Reclaimed w/ Check Valve ID (Purple)	458525
④	Wiper Seal	458600	
⑤	Spring	2"	630900
		3"	631000
		4"	459500
		6"	459700
		12"	459800
⑥	Riser	2"	630300
		3"	630400
		4"	424100
		6"	458700
		12"	458900
⑦	Check Valve Assembly	437400	
⑧	Body	2" w/o Side Inlet	630500
		3" w/o Side Inlet	630600
		4" w/o Side Inlet	424000
		6" w/ Side Inlet	458800
		12" w/ Side Inlet	459000
⑨	Side Plug ( <i>Not available on 4" model</i> )	460600	

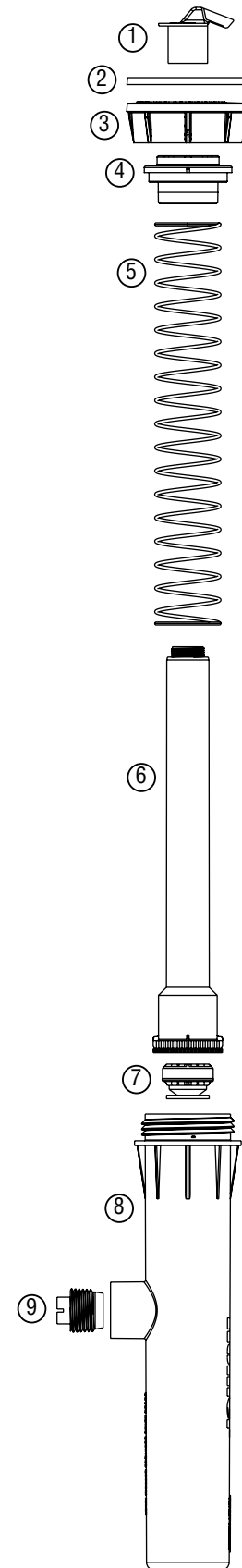

## PRODUCT OVERVIEW

When spray sprinklers are used in irrigation systems, fast and easy installation are two of the most important concerns for the installer. And, both of these concerns are put at ease when the installer chooses to use one of the many choices of Hunter spray nozzles. Whatever the particular landscape need, Hunter has the nozzles that can do the job best. In fact, any spray head body that uses female-threaded nozzles (whether a Hunter spray body or a competitor's) can have the ultimate in versatility with a Hunter nozzle.

**Adjustable Arc Nozzles: The Ultimate in Convenience.** Hunter's famous patented Adjustable Arc nozzles are fully adjustable from 25° to 360°, thus virtually every landscape need can be met. The nozzles are available in radius ranges of 8', 10', 12', 15', and 17', (2.4 m, 3.0 m, 3.7 m, 4.6 m, 5.2 m), and are color-coded in brown, red, green, black, and gray for fast and easy radius identification. The most notable advantage of the Adjustable Arc nozzle is that there is no need to keep an inventory of the many different odd arc nozzles seldom used on jobs.

**Pro-Spray Nozzles: Superior Coverage.** Hunter's Pro-Spray nozzles are factory set at a quarter, half, or full circle pattern. These nozzles are available in radius ranges of 8', 10', 12', 15', and 17', (2.4 m, 3.0 m, 3.7 m, 4.6 m, 5.2 m), and are also color coded in brown, red, green, black, and gray for fast and easy radius identification. In addition, Hunter now offers a trio of short-radius nozzles in 2', 4' and 6' ranges (0.6 m, 1.2 m, 1.8 m). These new nozzles are just the answer for small spaces that have longed for a better solution than trying to drastically reduce the radius range on a nozzle designed for longer throws.

The clear advantage of the Pro-Spray nozzle is an economic one. When installing nozzles along straight runs or in areas that require full circles, labor will be saved by not having to adjust each nozzle to these common patterns.

**Micro-Spray Nozzles: Vandal-Resistant, Low Volume Watering.** The unique pop-up design of the Hunter Micro-Spray Nozzle, coupled with the fact that it attaches directly to a female-threaded pop-up spray sprinkler, makes this alternative to drip a winner. When not in use, both the nozzle and the spray head body retract, so nothing sticks up above the surface. And when it's in operation, the pop-up nozzle gives nearly an extra inch of clearance over plants. With its many body options of various pop-up heights and nozzle selections, the Hunter spray line is a complete line, providing solutions to every landscape spray head application.

**Specialty Nozzles: Special Watering Requirements Made Easy.** For the specific watering needs of narrow areas of your landscape, Hunter offers a full range of nozzles for specialty applications. Three strip pattern nozzles are available, including a left corner, right corner, and side strip model. For the watering needs of slope or non-turf areas, the S-8A and S-16A nozzles can be used. These nozzles are adjustable-arc stream spray type nozzles providing a multiple stream spray pattern to cover any area from 25° to 360°, up to an 18' radius.

**PCN Bubbler Nozzles: The Alternative to Drip.** When bubblers are the apparent choice to water plantings, Hunter has a better solution: the PCN nozzle. This nozzle functions like a spray nozzle but operates like a bubbler by placing water around the riser. The PCN nozzle threads directly onto any female-thread pop-up spray head body, allowing it to retract to ground level. The result is no more unsightly bubbler risers sticking up out of the landscape. Because its ability to remain out of sight reduces vandalism and repair, the PCN is your best choice for traditional bubbler applications.

## PRODUCT FEATURES AND BENEFITS

### **Short Radius Nozzles...**

*2', 4', and 6' radius for those tight, hard-to-water areas*

Hunter now offers a trio of standard quarter and half arc pattern short-radius nozzles in your choice of radius: 2', 4', and 6' (0.6 m, 1.2 m, 1.8 m). These nozzles are just the answer for small spaces that have longed for a better solution than trying to drastically reduce the radius range on a nozzle designed for longer throws. Quarter and half only.

### **Strip Pattern Nozzles...**

*Narrow areas, no problem*

To accommodate the needs of those long, narrow planting strips, we offer the industry's widest variety of nozzle solutions, including 5' x 15' corner and end strips, 5' x 30' and 9' x 18' side strips, and a 5' x 30' center strip. The radius of these nozzles can be adjusted down 25% without loss of an efficient pattern distribution. And, no matter which nozzle you choose, each is an excellent problem solver for keeping your irrigation needs under control in tight areas.

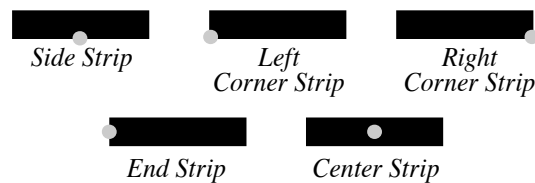

### **Stream Spray Nozzles...**

*Customized low application rate arcs*

Hunter also offers two dial-setting, adjustable arc stream spray nozzles that throw as far as 18' (5.9 m) at 30 PSI (206 kPa), combining the convenience of customized arc selection with a lower application rate. The stream spray is an outstanding nozzle to use on slopes and ground cover areas with tight soils as these applications typically require low precipitation rate nozzles.

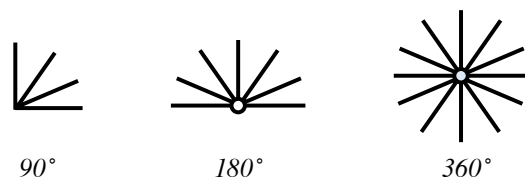

### **Filter Screen...**

*Large surface area*

Along with every nozzle comes a large filter screen that prevents clogging from debris in the water, ensuring uniform coverage. This filter is easy to install; it drops in from the top.



### **Matched Precipitation...**

*Even distribution of water regardless of the arc*

In properly installed irrigation systems, quarter-, half-, full-, and odd arcs are designed to be used on the same zone. Hunter spray nozzles produce true matched precipitation across most popular arc and radius ranges, with even distribution of water regardless of the arc. This allows for efficient, even distribution of water throughout the entire area. Hunter's matched precipitation nozzles increase customer satisfaction by providing a greener, healthier landscape.

### **Matched Precipitation Rate Sprinklers**

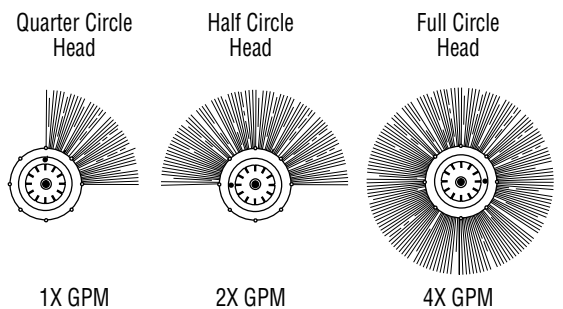

Radius of each sprinkler is equal

## PRODUCT FEATURES AND BENEFITS *(continued)*

### ***Standard Female Threaded Design...***

#### *Compatible with the most popular brands*

A variety of spray sprinkler bodies on the market today require a female threaded nozzle. All Hunter spray head nozzles meet that standard and are completely compatible with most major brands. This makes the nozzles ideal both for new installations and service of existing systems.

### ***Adjustable Arc Nozzles...***

#### *Quick and easy; performance at its max*

With an easy turn by hand, you can change the Adjustable Arc nozzles to keep the spray in the areas as designed. Fine-tuning can be made anywhere from 25° to 360°.

A particularly appealing feature of the Hunter nozzle is that no tools are required to adjust the arc.

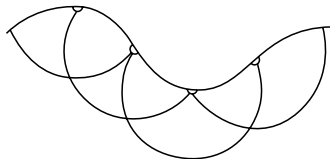

*The Adjustable Arc nozzle can be used for any area including areas that require custom odd arcs.*

### ***Pro-Spray® Nozzles...***

#### *Save time, save money*

For contractors that desire fixed pattern nozzles, Hunter offers a great array of models which are color-coded for easy identification.



### ***Numerous Radius Ranges of Standard Adjustable and Fixed Nozzles...***

#### *Versatile flow and throw*

Whether installing Adjustable Arc or a Fixed Arc nozzles, choose from an 8', 10', 12', 15', or 17' (2.4 m, 3.0 m, 3.7 m, 4.6 m, 5.2 m) radius range nozzle to meet the different design applications you might need. The radius can be reduced up to 25% without changing the pattern distribution characteristics.

### ***Micro-Spray Nozzles...***

#### *The sensible alternative to drip irrigation*

For shrubs and flowerbeds that require 100% irrigated coverage, sometimes a low pressure/low volume irrigation system is not the type of watering you're looking for. With the revolutionary Hunter Micro-Spray Nozzles, excellent coverage with an accurate distribution of water is the norm for a 4-5 foot radius. Contractors will find these Micro-Sprays very user-friendly because of their ability to work under full line pressure and no additional filtration is needed. Unlike regular sprays that discharge a lot of water with higher force, these nozzles send out a finer spray that will not create "run-off" or damage plants. The nozzles attach directly to any Hunter spray body, so no special installations, such as filters, or retrofits are required. And because the Micro-Spray is itself a pop-up, the nozzle retracts and hides from view when not in use—making them vandal-proof and creating a more eye-pleasing appearance.

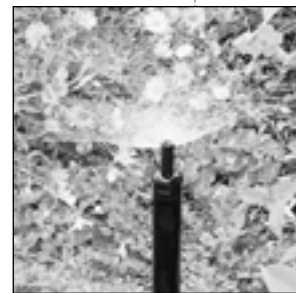

## PRODUCT PERFORMANCE

Pro-Spray® Nozzles Performance Data																						
Arc	Pressure PSI	Pattern	8 Foot Radius Fixed (Quarter, Half, Full) Nozzle Trajectory: 0° Color Code: Brown ● 8			10 Foot Radius Fixed (Quarter, Half, Full) Nozzle Trajectory: 15° Color Code: Red ● 10			12 Foot Radius Fixed (Quarter, Half, Full) Nozzle Trajectory: 28° Color Code: Green ● 12			15 Foot Radius Fixed (Quarter, Half, Full) Nozzle Trajectory: 28° Color Code: Black ● 15			17 Foot Radius Fixed (Quarter) Nozzle Trajectory: 28° Color Code: Gray ● 17							
			Radius ft.	Flow GPM	Precip in/hr	Radius ft.	Flow GPM	Precip in/hr	Radius ft.	Flow GPM	Precip in/hr	Radius ft.	Flow GPM	Precip in/hr	Radius ft.	Flow GPM	Precip in/hr					
90°	20	Q	7'	0.17	1.34	1.54	9'	0.30	1.43	1.65	11'	0.50	1.59	1.84	14'	0.77	1.51	1.75	16'	0.97	1.46	1.68
	25		8'	0.19	1.14	1.32	10'	0.33	1.27	1.47	12'	0.55	1.47	1.70	15'	0.86	1.47	1.70	17'	1.13	1.51	1.74
	30		8'	<b>0.24</b>	<b>1.44</b>	<b>1.67</b>	10'	<b>0.39</b>	<b>1.50</b>	<b>1.73</b>	12'	<b>0.63</b>	<b>1.68</b>	<b>1.95</b>	15'	<b>0.93</b>	<b>1.59</b>	<b>1.84</b>	17'	<b>1.20</b>	<b>1.60</b>	<b>1.85</b>
	35		9'	0.33	1.57	1.81	11'	0.49	1.56	1.80	13'	0.73	1.66	1.92	16'	1.03	1.55	1.79	18'	1.25	1.49	1.72
	40		10'	0.48	1.85	2.13	12'	0.63	1.68	1.95	14'	0.84	1.65	1.91	17'	1.13	1.51	1.74	19'	1.38	1.47	1.70
180°	20	H	7'	0.34	1.34	1.54	9'	0.60	1.43	1.65	11'	1.00	1.59	1.84	14'	1.54	1.51	1.75	16'	1.94	1.46	1.68
	25		8'	0.38	1.14	1.32	10'	0.66	1.27	1.47	12'	1.10	1.47	1.70	15'	1.72	1.47	1.70	17'	2.26	1.51	1.74
	30		8'	<b>0.48</b>	<b>1.44</b>	<b>1.67</b>	10'	<b>0.82</b>	<b>1.58</b>	<b>1.82</b>	12'	<b>1.31</b>	<b>1.75</b>	<b>2.02</b>	15'	<b>1.86</b>	<b>1.59</b>	<b>1.84</b>	17'	<b>2.40</b>	<b>1.60</b>	<b>1.85</b>
	35		9'	0.66	1.57	1.81	11'	0.98	1.56	1.80	13'	1.46	1.66	1.92	16'	2.06	1.55	1.79	18'	2.50	1.49	1.72
	40		10'	0.96	1.85	2.13	12'	1.26	1.68	1.95	14'	1.68	1.65	1.91	17'	2.26	1.51	1.74	19'	2.76	1.47	1.70
360°	20	F	7'	0.68	1.34	1.54	9'	1.20	1.43	1.65	11'	2.00	1.59	1.84	14'	3.08	1.51	1.75	16'	3.88	1.46	1.68
	25		8'	0.76	1.14	1.32	10'	1.32	1.27	1.47	12'	2.20	1.47	1.70	15'	3.44	1.47	1.70	17'	4.52	1.51	1.74
	30		8'	<b>0.95</b>	<b>1.43</b>	<b>1.65</b>	10'	<b>1.62</b>	<b>1.56</b>	<b>1.80</b>	12'	<b>2.65</b>	<b>1.77</b>	<b>2.05</b>	15'	<b>3.72</b>	<b>1.59</b>	<b>1.84</b>	17'	<b>4.80</b>	<b>1.60</b>	<b>1.85</b>
	35		9'	1.32	1.57	1.81	11'	1.96	1.56	1.80	13'	2.92	1.66	1.92	16'	4.12	1.55	1.79	18'	5.00	1.49	1.72
	40		10'	1.92	1.85	2.13	12'	2.52	1.68	1.95	14'	3.36	1.65	1.91	17'	4.54	1.51	1.74	19'	5.52	1.47	1.70

Note: The Institutional Spray's built-in pressure regulation controls output to a maximum of 30 PSI. All precipitation rates calculated for 360 degree operation.

Pro-Spray® Nozzles Performance Data – Metric																												
Arc	Pattern	Pressure Bars	kPa	2.4 Meter Radius (8 ft.) Fixed (Quarter, Half, Full) Nozzle Trajectory: 0° Color Code: Brown ● 8				3.0 Meter Radius (10 ft.) Fixed (Quarter, Half, Full) Nozzle Trajectory: 15° Color Code: Red ● 10				3.7 Meter Radius (12 ft.) Fixed (Quarter, Half, Full) Nozzle Trajectory: 28° Color Code: Green ● 12				4.6 Meter Radius (15 ft.) Fixed (Quarter, Half, Full) Nozzle Trajectory: 28° Color Code: Black ● 15				5.2 Meter Radius (17 ft.) Fixed (Quarter) Nozzle Trajectory: 28° Color Code: Gray ● 17								
				Radius m	Flow m <sup>3</sup> /hr	Flow l/min	Precip mm/hr	Radius m	Flow m <sup>3</sup> /hr	Flow l/min	Precip mm/hr	Radius m	Flow m <sup>3</sup> /hr	Flow l/min	Precip mm/hr	Radius m	Flow m <sup>3</sup> /hr	Flow l/min	Precip mm/hr	Radius m	Flow m <sup>3</sup> /hr	Flow l/min	Precip mm/hr					
90°	Q	1.4	137	2.1	0.04	0.6	34	39	2.7	0.07	1.1	36	42	3.4	0.11	1.9	40	47	4.2	0.17	2.9	38	44	4.9	0.22	3.7	37	43
		1.7	171	2.4	0.04	0.7	29	34	3.0	0.07	1.3	37	44	3.7	0.12	2.1	37	43	4.5	0.20	3.3	37	43	5.2	0.26	4.3	38	44
		2.1	<b>206</b>	<b>2.4</b>	<b>0.05</b>	<b>0.9</b>	<b>37</b>	<b>42</b>	<b>3.0</b>	<b>0.09</b>	<b>1.5</b>	<b>44</b>	<b>55</b>	<b>3.7</b>	<b>0.14</b>	<b>2.4</b>	<b>43</b>	<b>49</b>	<b>4.5</b>	<b>0.21</b>	<b>3.5</b>	<b>40</b>	<b>47</b>	<b>5.2</b>	<b>0.27</b>	<b>4.5</b>	<b>41</b>	<b>47</b>
		2.4	240	2.7	0.07	1.3	40	46	3.3	0.11	1.9	46	48	4.0	0.17	2.8	42	49	4.8	0.23	3.9	39	45	5.5	0.28	4.7	38	44
		2.7	274	3.0	0.11	1.8	47	54	3.6	0.14	2.4	49	57	4.3	0.19	3.2	42	48	5.2	0.26	4.3	38	44	5.8	0.31	5.2	37	43
180°	H	1.4	137	2.1	0.08	1.3	34	39	2.7	0.14	2.3	42	47	3.4	0.23	3.8	40	47	4.2	0.35	5.8	38	44	4.9	0.44	7.3	37	43
		1.7	171	2.4	0.09	1.4	29	34	3.0	0.15	2.5	37	44	3.7	0.25	4.2	37	43	4.5	0.39	6.5	37	43	5.2	0.51	8.6	38	44
		2.1	<b>206</b>	<b>2.4</b>	<b>0.11</b>	<b>1.8</b>	<b>37</b>	<b>42</b>	<b>3.0</b>	<b>0.19</b>	<b>3.1</b>	<b>46</b>	<b>55</b>	<b>3.7</b>	<b>0.30</b>	<b>5.0</b>	<b>44</b>	<b>51</b>	<b>4.5</b>	<b>0.42</b>	<b>7.0</b>	<b>40</b>	<b>47</b>	<b>5.2</b>	<b>0.54</b>	<b>9.1</b>	<b>41</b>	<b>47</b>
		2.4	240	2.7	0.15	2.5	30	46	3.3	0.22	3.7	46	48	4.0	0.33	5.5	42	49	4.8	0.47	7.8	39	45	5.5	0.57	9.5	38	44
		2.7	274	3.0	0.22	3.6	35	54	3.6	0.29	4.8	49	57	4.3	0.38	6.4	42	48	5.2	0.51	8.6	38	44	5.8	0.63	10.5	37	43
360°	F	1.4	137	2.1	0.15	2.6	34	39	2.7	0.27	4.5	42	47	3.4	0.45	7.6	40	47	4.2	0.70	11.7	38	44	4.9	0.88	14.7	37	43
		1.7	171	2.4	0.17	2.9	29	34	3.0	0.30	5.0	37	44	3.7	0.50	8.3	37	43	4.5	0.78	13.0	37	43	5.2	1.03	17.1	38	44
		2.1	<b>206</b>	<b>2.4</b>	<b>0.22</b>	<b>3.6</b>	<b>36</b>	<b>42</b>	<b>3.0</b>	<b>0.37</b>	<b>6.1</b>	<b>46</b>	<b>55</b>	<b>3.7</b>	<b>0.60</b>	<b>10.0</b>	<b>45</b>	<b>52</b>	<b>4.5</b>	<b>0.84</b>	<b>14.1</b>	<b>40</b>	<b>47</b>	<b>5.2</b>	<b>1.09</b>	<b>18.2</b>	<b>41</b>	<b>47</b>
		2.4	240	2.7	0.30	5.0	40	46	3.3	0.44	7.4	46	48	4.0	0.66	11.1	42	49	4.8	0.94	15.6	39	45	5.5	1.14	18.9	38	44
		2.7	274	3.0	0.44	7.3	47	54	3.6	0.57	9.5	49	57	4.3	0.76	12.7	42	48	5.2	1.03	17.1	38	44	5.8	1.25	20.9	37	43

Note: The Institutional Spray's built-in pressure regulation controls output to a maximum of 2.1 Bars (206 kPa).

## PRODUCT PERFORMANCE (continued)

Adjustable Arc Nozzles Performance Data																					
Arc	Pressure PSI	8 Foot Radius Adjustable from 25° to 360° Nozzle Trajectory: 0° Color Code: Brown ● <b>8A</b>				10 Foot Radius Adjustable from 25° to 360° Nozzle Trajectory: 15° Color Code: Red ● <b>10A</b>				12 Foot Radius Adjustable from 25° to 360° Nozzle Trajectory: 28° Color Code: Green ● <b>12A</b>				15 Foot Radius Adjustable from 25° to 360° Nozzle Trajectory: 28° Color Code: Black ● <b>15A</b>				17 Foot Radius Adjustable from 25° to 360° Nozzle Trajectory: 28° Color Code: Gray ● <b>17A</b>			
		Radius ft.	Flow GPM	Precip in/hr	Precip in/hr	Radius ft.	Flow GPM	Precip in/hr	Precip in/hr	Radius ft.	Flow GPM	Precip in/hr	Precip in/hr	Radius ft.	Flow GPM	Precip in/hr	Precip in/hr	Radius ft.	Flow GPM	Precip in/hr	Precip in/hr
45°	20	7'	0.17	2.67	3.08	9'	0.17	1.62	1.87	11'	0.25	1.59	1.84	14'	0.39	1.51	1.75	16'	0.49	1.46	1.68
	25	8'	0.20	2.35	2.71	10'	0.20	1.50	1.73	12'	0.28	1.47	1.70	15'	0.43	1.47	1.70	17'	0.57	1.51	1.74
	30	8'	<b>0.25</b>	<b>2.95</b>	<b>3.40</b>	10'	<b>0.25</b>	<b>1.89</b>	<b>2.18</b>	12'	<b>0.32</b>	<b>1.68</b>	<b>1.95</b>	15'	<b>0.47</b>	<b>1.59</b>	<b>1.84</b>	17'	<b>0.60</b>	<b>1.60</b>	<b>1.85</b>
	35	9'	0.26	2.42	2.80	11'	0.26	1.62	1.87	13'	0.37	1.66	1.92	16'	0.52	1.55	1.79	18'	0.63	1.49	1.72
90°	20	10'	0.37	2.81	3.25	12'	0.37	1.95	2.25	14'	0.42	1.65	1.91	17'	0.57	1.51	1.74	19'	0.69	1.47	1.70
	25	7'	0.34	2.67	3.08	9'	0.34	1.62	1.87	11'	0.50	1.59	1.84	14'	0.77	1.51	1.75	16'	0.97	1.46	1.68
	30	8'	0.39	2.35	2.71	10'	0.39	1.50	1.73	12'	0.55	1.47	1.70	15'	0.86	1.47	1.70	17'	1.13	1.51	1.74
	35	9'	0.51	2.42	2.80	11'	0.51	1.62	1.87	13'	0.73	1.66	1.92	16'	1.03	1.55	1.79	18'	1.25	1.49	1.72
120°	20	10'	0.73	2.81	3.25	12'	0.73	1.95	2.25	14'	0.84	1.65	1.91	17'	1.13	1.51	1.74	19'	1.38	1.47	1.70
	25	7'	0.45	2.67	3.08	9'	0.45	1.62	1.87	11'	0.67	1.59	1.84	14'	1.03	1.51	1.75	16'	1.29	1.46	1.68
	30	8'	0.52	2.35	2.71	10'	0.52	1.50	1.73	12'	0.73	1.47	1.70	15'	1.15	1.47	1.70	17'	1.51	1.51	1.74
	35	9'	0.68	2.42	2.80	11'	0.68	1.62	1.87	13'	0.97	1.66	1.92	16'	1.37	1.55	1.79	18'	1.67	1.49	1.72
180°	20	10'	0.97	2.81	3.25	12'	0.97	1.95	2.25	14'	1.12	1.65	1.91	17'	1.51	1.51	1.74	19'	1.84	1.47	1.70
	25	7'	0.68	2.67	3.08	9'	0.68	1.62	1.87	11'	1.00	1.59	1.84	14'	1.54	1.51	1.75	16'	1.94	1.46	1.68
	30	8'	0.78	2.35	2.71	10'	0.78	1.50	1.73	12'	1.10	1.47	1.70	15'	1.72	1.47	1.70	17'	2.26	1.51	1.74
	35	9'	1.02	2.42	2.80	11'	1.02	1.62	1.87	13'	1.46	1.66	1.92	16'	2.06	1.55	1.79	18'	2.50	1.49	1.72
240°	20	10'	1.46	2.81	3.25	12'	1.46	1.95	2.25	14'	1.68	1.65	1.91	17'	2.26	1.51	1.74	19'	2.76	1.47	1.70
	25	7'	0.91	2.67	3.08	9'	0.91	1.62	1.87	11'	1.33	1.59	1.84	14'	2.05	1.51	1.75	16'	2.59	1.46	1.68
	30	8'	1.04	2.35	2.71	10'	1.04	1.50	1.73	12'	1.47	1.47	1.70	15'	2.29	1.47	1.70	17'	3.01	1.51	1.74
	35	9'	1.36	2.42	2.80	11'	1.36	1.62	1.87	13'	1.95	1.66	1.92	16'	2.75	1.55	1.79	18'	3.33	1.49	1.72
270°	20	10'	1.95	2.81	3.25	12'	1.95	1.95	2.25	14'	2.24	1.65	1.91	17'	3.01	1.51	1.74	19'	3.68	1.47	1.70
	25	7'	1.02	2.67	3.08	9'	1.02	1.62	1.87	11'	1.50	1.59	1.84	14'	2.31	1.51	1.75	16'	2.91	1.46	1.68
	30	8'	1.17	2.35	2.71	10'	1.17	1.50	1.73	12'	1.65	1.47	1.70	15'	2.58	1.47	1.70	17'	3.39	1.51	1.74
	35	9'	1.53	2.42	2.80	11'	1.53	1.62	1.87	13'	2.19	1.66	1.92	16'	3.09	1.55	1.79	18'	3.75	1.49	1.72
360°	20	10'	2.19	2.81	3.25	12'	2.19	1.95	2.25	14'	2.52	1.65	1.91	17'	3.39	1.51	1.74	19'	4.14	1.47	1.70
	25	7'	1.36	2.67	3.08	9'	1.36	1.62	1.87	11'	2.00	1.59	1.84	14'	3.08	1.51	1.75	16'	3.88	1.46	1.68
	30	8'	1.56	2.35	2.71	10'	1.56	1.50	1.73	12'	2.20	1.47	1.70	15'	3.44	1.47	1.70	17'	4.52	1.51	1.74
	35	9'	2.04	2.42	2.80	11'	2.04	1.62	1.87	13'	2.92	1.66	1.92	16'	4.12	1.55	1.79	18'	5.00	1.49	1.72
40	10'	2.92	2.81	3.25	12'	2.92	1.95	2.25	14'	3.36	1.65	1.91	17'	4.52	1.51	1.74	19'	5.52	1.47	1.70	

Note: The Institutional Spray's built-in pressure regulation controls output to a maximum of 30 PSI.

Strip Pattern Nozzle Performance Data				
Color Code: Blue ●				
Nozzle Model	Pressure PSI	Width x Length	Flow GPM	Precip in/hr
LCS-515 Left-Corner Strip	20	4' x 14'	0.55	0.95
	25	5' x 15'	0.60	0.77
	30	5' x 15'	<b>0.65</b>	<b>0.83</b>
	35	5' x 15'	0.70	0.90
RCS-515 Right-Corner Strip	20	4' x 14'	0.55	0.95
	25	5' x 15'	0.60	0.77
	30	5' x 15'	<b>0.65</b>	<b>0.83</b>
	35	5' x 15'	0.70	0.90
SS-530 Side Strip	20	5' x 30'	1.10	0.95
	25	5' x 30'	1.20	0.77
	30	5' x 30'	<b>1.30</b>	<b>0.83</b>
	35	5' x 30'	1.40	0.90
40	5' x 30'	1.50	0.96	



Model S-8A Stream Spray Nozzle Performance Data					
Adjustable from 25° to 360°					
Color Code: Blue ●					
Arc	Pressure PSI	Radius ft.	Flow GPM	Precip in/hr	
90°	20	7	0.29	2.28	2.63
	25	8	0.32	1.93	2.22
	30	8	<b>0.35</b>	<b>2.11</b>	<b>2.43</b>
	35	8	0.38	2.29	2.64
180°	20	7	0.54	2.12	2.45
	25	8	0.57	1.71	1.98
	30	8	<b>0.60</b>	<b>1.80</b>	<b>2.08</b>
	35	8	0.63	1.89	2.19
360°	20	7	0.66	1.57	1.81
	25	7	1.08	2.12	2.45
	25	8	1.11	1.67	1.93
	30	8	<b>1.15</b>	<b>1.73</b>	<b>2.00</b>
35	8	1.18	1.77	2.05	
40	9	1.22	1.45	1.67	



Model S-16A Stream Spray Nozzle Performance Data					
Adjustable from 25° to 360°					
Color Code: Blue ●					
Arc	Pressure PSI	Radius ft.	Flow GPM	Precip in/hr	
90°	20	15	0.40	0.68	0.79
	25	16	0.46	0.69	0.80
	30	16	<b>0.50</b>	<b>0.75</b>	<b>0.87</b>
	35	17	0.54	0.72	0.83
180°	20	15	0.67	0.57	0.66
	25	16	0.80	0.60	0.69
	30	16	<b>0.88</b>	<b>0.66</b>	<b>0.76</b>
	35	17	0.97	0.65	0.75
360°	20	15	1.19	0.51	0.59
	25	16	1.46	0.55	0.63
	30	16	<b>1.66</b>	<b>0.62</b>	<b>0.72</b>
	35	17	1.82	0.61	0.70
40	18	1.99	0.59	0.68	



Data represents test results in zero wind. Adjust for local conditions.





## PRODUCT PERFORMANCE (continued)

Micro-Spray Nozzles Performance Data						
Arc	Pressure PSI	Nozzle	Radius ft.	Flow GPM	Precip in/hr ■ ▲	
90° 	25	<b>MS-Q</b>	5'	0.12	1.85	2.13
	40		5'	0.14	2.16	2.49
	60		5'	0.14	2.16	2.49
180° 	25	<b>MS-H</b>	5'	0.25	1.93	2.22
	40		5'	0.28	2.16	2.49
	60		5'	0.29	2.23	2.58
360° 	25	<b>MS-F</b>	5'	0.50	1.93	2.22
	40		5'	0.56	2.16	2.49
	60		5'	0.58	2.23	2.58

Micro-Spray Nozzles Performance Data – Metric							
Arc	Pressure Bars kPa	Nozzle	Radius m	Flow m³/hr l/min	Precip mm/hr ■ ▲		
90° 	1.7 172	<b>MS-Q</b>	1.5	0.03 0.45	47	54	
	2.8 275		1.5	0.03 0.53	55	63	
	4.1 413		1.5	0.03 0.53	55	63	
180° 	1.7 172	<b>MS-H</b>	1.5	0.06 0.95	49	56	
	2.8 275		1.5	0.06 1.06	55	63	
	4.1 413		1.5	0.07 1.10	57	65	
360° 	1.7 172	<b>MS-F</b>	1.5	0.11 1.89	49	56	
	2.8 275		1.5	0.13 2.12	55	63	
	4.1 413		1.5	0.13 2.20	57	65	

Short Radius Nozzles Performance Data																
Arc	Pressure PSI	Color Code: Light Brown ●				Color Code: Light Green ●				Color Code: Light Blue ●						
		Nozzle	Radius ft.	Flow GPM	Precip in/hr ■ ▲	Nozzle	Radius ft.	Flow GPM	Precip in/hr ■ ▲	Nozzle	Radius ft.	Flow GPM	Precip in/hr ■ ▲			
90° 	20	<b>2Q</b>	2'	0.09	8.66	10.00	<b>4Q</b>	4'	0.20	4.81	5.56	<b>6Q</b>	6'	0.47	5.03	5.80
	25		2'	0.10	9.63	11.11		4'	0.22	5.29	6.11		6'	0.49	5.24	6.05
	<b>30</b>		<b>2'</b>	<b>0.11</b>	<b>10.59</b>	<b>12.23</b>		<b>4'</b>	<b>0.22</b>	<b>5.29</b>	<b>6.11</b>		<b>6'</b>	<b>0.51</b>	<b>5.45</b>	<b>6.30</b>
	35		2'	0.12	11.55	13.34		4'	0.24	5.78	6.67		6'	0.52	5.56	6.42
	40		2'	0.14	13.48	15.56		4'	0.24	5.78	6.67		6'	0.52	5.56	6.42
180° 	20	<b>2H</b>	2'	0.12	5.78	6.67	<b>4H</b>	4'	0.41	4.93	5.70	<b>6H</b>	6'	0.95	5.08	5.87
	25		2'	0.14	6.74	7.78		4'	0.43	5.17	5.97		6'	0.97	5.19	5.99
	<b>30</b>		<b>2'</b>	<b>0.16</b>	<b>7.70</b>	<b>8.89</b>		<b>4'</b>	<b>0.44</b>	<b>5.29</b>	<b>6.11</b>		<b>6'</b>	<b>0.98</b>	<b>5.24</b>	<b>6.05</b>
	35		2'	0.18	8.66	10.00		4'	0.46	5.53	6.39		6'	0.99	5.29	6.11
	40		2'	0.18	8.66	10.00		4'	0.46	5.53	6.39		6'	1.00	5.35	6.17

Short Radius Nozzles Performance Data – Metric																			
Arc	Pressure Bars kPa	Color Code: Light Brown ●				Color Code: Light Green ●				Color Code: Light Blue ●									
		Nozzle	Radius m	Flow m³/hr l/min	Precip mm/hr ■ ▲	Nozzle	Radius m	Flow m³/hr l/min	Precip mm/hr ■ ▲	Nozzle	Radius ft.	Flow m³/hr l/min	Precip mm/hr ■ ▲						
90° 	1.4 137	<b>2Q</b>	0.6	0.02	0.34	220	254	<b>4Q</b>	1.2	0.05	0.76	122	141	<b>6Q</b>	1.8	0.11	1.78	128	147
	1.7 172		0.6	0.02	0.38	244	282		1.2	0.05	0.81	134	155		1.8	0.11	1.85	133	154
	<b>2.1 206</b>		<b>0.6</b>	<b>0.02</b>	<b>0.42</b>	<b>269</b>	<b>311</b>		<b>1.2</b>	<b>0.05</b>	<b>0.83</b>	<b>134</b>	<b>155</b>		<b>1.8</b>	<b>0.12</b>	<b>1.93</b>	<b>139</b>	<b>160</b>
	2.4 241		0.6	0.03	0.45	293	339		1.2	0.05	0.91	147	169		1.8	0.12	1.97	141	163
	2.8 275		0.6	0.03	0.53	342	395		1.2	0.05	0.91	147	169		1.8	0.12	1.97	141	163
180° 	1.4 137	<b>2H</b>	0.6	0.03	0.45	147	169	<b>4H</b>	1.2	0.09	1.55	125	145	<b>6H</b>	1.8	0.22	3.60	129	149
	1.7 172		0.6	0.03	0.53	171	198		1.2	0.10	1.63	131	152		1.8	0.22	3.67	132	152
	<b>2.1 206</b>		<b>0.6</b>	<b>0.04</b>	<b>0.61</b>	<b>196</b>	<b>226</b>		<b>1.2</b>	<b>0.10</b>	<b>1.67</b>	<b>134</b>	<b>155</b>		<b>1.8</b>	<b>0.22</b>	<b>3.71</b>	<b>133</b>	<b>154</b>
	2.4 241		0.6	0.04	0.68	220	254		1.2	0.10	1.74	141	162		1.8	0.22	3.75	134	155
	2.8 275		0.6	0.04	0.68	220	254		1.2	0.10	1.74	141	162		1.8	0.23	3.79	136	157

**SPECIFICATION GUIDE**

EXAMPLE: **2Q**

<b>MODELS</b> 2 = 2' Short Radius Nozzle 4 = 4' Short Radius Nozzle 6 = 6' Short Radius Nozzle	<b>PATTERN</b> Q = Quarter-Circle Pattern H = Half-Circle Pattern
---	---

**SPECIFICATION GUIDE**

EXAMPLE: **15 - A**

<b>MODELS</b> 8 = 8' Radius 10 = 10' Radius 12 = 12' Radius 15 = 15' Radius 17 = 17' Radius*	<b>PATTERN</b> Q = Quarter-Circle H = Half-Circle F = Full-Circle
---	--

\* 17 Series available in Quarter-Circle pattern only.

**SPECIFICATION GUIDE**

EXAMPLE: **S-16A**

<b>MODELS</b> S-16A = Stream Spray Nozzle, 16' Radius, Adjustable Arc S-8A = Description goes here Second Line If Needed
--

**SPECIFICATION GUIDE**

EXAMPLE: **LCS-515**

<b>MODELS</b> LCS-515 = Left-Corner Strip Nozzle, 5' x 15' Pattern RCS-515 = Right-Corner Strip Nozzle, 5' x 15' Pattern SS-530 = Side-Strip Nozzle, 5' x 30' Pattern SS-918 = Side-Strip Nozzle, 9' x 18' Pattern CS-530 = Center-Strip Nozzle, 5' x 30' Pattern ES-515 = End-Strip Nozzle, 5' x 15' Pattern
---

**SPECIFICATION GUIDE**

EXAMPLE: **MS - Q**

<b>MODELS</b> MS = Micro-Spray Nozzle, 5' Radius	<b>PATTERN</b> Q = Quarter-Circle Pattern H = Half-Circle Pattern F = Full-Circle Pattern
---	--



## PRODUCT COMPARISONS

FEATURES - Adjustable Arc Nozzle	Hunter® ADJ	Toro® V-15	Rain Bird® VAN
Popular Female Threaded Nozzle	✓		✓
Arc adjustable without using tools	✓		✓
Multiple Radius Ranges available	✓		✓
Filter screen included	✓	✓	✓

FEATURES - Fixed Arc Nozzle	Hunter® Fixed Arc	Toro® Fixed Arc	Rain Bird® MPR
Popular Female Threaded Nozzle	✓		✓
2'-18' Radius Ranges	✓		
Color-coded for easy ID	✓	✓	
Filter screen included	✓	✓	✓

## INSTALLATION AND MAINTENANCE

### Installation Instructions

1. Install sprinklers onto lateral lines.
2. Flush lines, making sure the flush caps are directed away from trench.
3. Install screen into riser opening and screw female-threaded nozzle onto riser.
4. Adjust arc and radius for each sprinkler as described below.

### Arc Adjustment on Nozzles

The Hunter Adjustable Arc nozzles come from the factory with a preset arc of 25°. Before setting the left side of the arc, first set the right ratcheting side by twisting the riser assembly

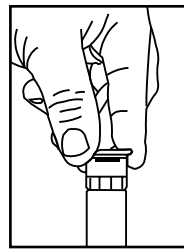

inside of the sprinkler body, aligning the right side of the spray pattern into the proper area. The raised dot on top of the nozzle indicates the adjustable (left) edge of the spray pattern. Hold the perimeter of the nozzle with fingers and turn the nozzle counter-clockwise to increase the arc. To decrease the arc, hold the perimeter of the nozzle with fingers and turn the nozzle clockwise, decreasing the arc. The arc can also be increased or decreased by using a flat bladed screwdriver.

inside of the sprinkler body, aligning the right side of the spray pattern into the proper area. The raised dot on top of the nozzle indicates the adjustable (left) edge of the spray pattern. Hold the perimeter of the nozzle with fingers and turn the nozzle counter-clockwise to increase the arc. To decrease the arc, hold the perimeter of the nozzle with fingers and turn the nozzle clockwise, decreasing the arc. The arc can also be increased or decreased by using a flat bladed screwdriver.

### Radius Adjustment

Hold the nozzle arc stationary with fingers, or with two pins on the side of the Hunter wrench between any of the nozzle spokes. Then, adjust the radius with a flat-bladed screwdriver by turning the center screw clockwise.

The radius should not be reduced more than 25%. The nozzles are preset at the factory for maximum radius.

The radius should not be reduced more than 25%. The nozzles are preset at the factory for maximum radius.

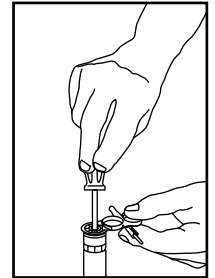

## PRODUCT FEATURES AND BENEFITS

### PCN Bubbler Nozzle...

#### Out of sight bubbler watering

Hunter has developed the ultimate in deep watering technology with the PCN Bubbler Nozzle. This nozzle is specially designed to screw on to the SRS spray head and most other female threaded spray head bodies on the market today. This means you get all the advantages of traditional flood bubbler watering with a product that retracts into the ground when not in use. Using the PCN Bubbler you will find that the maintenance hassles of other deep watering methods, such as drip, are eliminated. It's the most tamper-proof, eye-appealing method of deep watering available today. With four flow rates to choose from (.25, .50, 1.0, 2.0 GPM; .9, 1.9, 3.8, 7.6 l/min) the PCN can be used in many different soil types with little concern of runoff.



#### PCN Nozzle & PCB Performance Data

Model	Pressure PSI	Flow GPM	Pattern Type
25	30	0.25	Trickle
50	30	0.50	Trickle
10	30	1.00	Pattern
20	30	2.00	Pattern

Note: Typical spacing 1 to 3 ft.

#### PCN Nozzle & PCB Performance Data – Metric

Model	Pressure Bars	Pressure kPa	Flow m <sup>3</sup> /hr	Flow l/min	Pattern Type
25	2.1	206	0.06	0.9	Trickle
50	2.1	206	0.11	1.9	Trickle
10	2.1	206	0.23	3.8	Pattern
20	2.1	206	0.45	7.6	Pattern

Note: Typical spacing 0.3 to 0.9 m.

#### SPECIFICATION GUIDE

EXAMPLE: **PCB - 25**

#### MODELS

PCB = " FIP T

PCN = Standard Female Nozzle Thread

AFB = " FIPT

#### FLOW

25 = .25 GPM

50 = .50 GPM

10 = 1.0 GPM

20 = 2.0 GPM

Adjustable Flow

### PCB Bubblers...

#### No need to guess with specific flow rates

For trees and shrubs that are off the beaten path, and for out of the way places, PCB is your low cost deep watering option. The PCB installs quickly and easily to any ½ inch NPT threaded riser or adapter. And, with our line-up of four different PCB models, that means you can select precisely the one you need to meet each of your individual plant's watering requirements. Choose from flow rates of either .25, .50, 1.0, or 2.0 GPM (.9, 1.9, 3.8, 7.6 l/min) to eliminate guesswork and guarantee that all your greenery gets exactly the water it needs.

Choose the AFB model which pressure compensates to a 2.0 GPM (7.6 l/min) flow and can be fine-tuned with a stainless steel screw adjustment.



#### Multi-Stream Bubbler Performance Data

Arc	Model	Pressure PSI	Flow GPM	Radius ft.
1/2"	MSBN-25Q	30	0.25	1.0
	MSBN-50Q	30	0.50	1.5
3/4"	MSBN-50H	30	0.50	1.0
	MSBN-10H	30	1.00	1.5
1"	MSBN-10F	30	1.00	1.0
	MSBN-20F	30	2.00	1.5

Note: Typical spacing 2 to 4 ft.

#### Multi-Stream Bubbler Nozzle – Metric

Arc	Model	Pressure Bars	Pressure kPa	Flow m <sup>3</sup> /hr	Flow l/min	Radius m
1/2"	MSBN-25Q	2.0	206	0.06	0.9	0.30
	MSBN-50Q	2.0	206	0.11	1.9	0.46
3/4"	MSBN-50H	2.0	206	0.11	1.9	0.30
	MSBN-10H	2.0	206	0.23	3.8	0.46
1"	MSBN-10F	2.0	206	0.23	3.8	0.30
	MSBN-20F	2.0	206	0.45	7.6	0.46

Note: Typical spacing 0.6 to 1.2 m.

## PRECIPITATION RATE FORMULA

Two formulas are shown below, the first is most useful when comparing precipitation rates between different types of sprinklers or calculating precipitation rates on areas with a single type of sprinkler and uniform head and row spacing. The second method is better suited to areas where sprinkler head flows or spacing varies. Metric versions are shown in parenthesis.

### Precipitation Rate - Method #1 - Individual Head Method

$$Pr = \frac{34650 \times \text{GPM (for any arc)}}{\text{Degrees Arc} \times \text{Head Spacing} \times \text{Row Spacing}}$$

$$Pr = \frac{\text{l/min (for any arc)} \times 21,600}{\text{Degrees of arc} \times \text{Head spacing (m)} \times \text{Row Spacing (m)}} \text{ mm/hr}$$

$$Pr = \frac{\text{m}^3/\text{hr (for any arc)} \times 360,000}{\text{Degrees of arc} \times \text{Head spacing (m)} \times \text{Row Spacing (m)}}$$

Where:

Pr	=	precipitation rate in inches per hour
GPM	=	flow for a given sprinkler of any arc, in gallons per minute
Degrees Arc	=	the arc of the given sprinkler in degrees
Head Spacing	=	the space between the heads in a row, in feet
Row Spacing	=	the space between rows of heads, in feet
34650	=	constant for conversion of area and flow into common units

Example: What is the precipitation rate for a 270 degree sprinkler with 6.8 GPM spaced at 28' by 30'?

$$Pr = \frac{34,650 \times 6.8}{270 \times 28 \times 30} \qquad Pr = 1.04 \text{ in./hr.}$$

### Precipitation Rate - Method #2 - Total Area Method

$$Pr = \frac{96.25 \times \text{Total GPM}}{\text{Total Area}} \quad \left( Pr = \frac{\text{Total m}^3/\text{hr} \times 1,000}{\text{Total Area (m}^2)} = \text{mm/hr} \right) \quad \left( Pr = \frac{\text{Total l/min} \times 60}{\text{Total Area (m}^2)} = \text{mm/hr} \right)$$

Where:

Pr	=	precipitation rate in inches per hour
Total GPM	=	total flow from all sprinklers in the given area in gallons per minute
Total Area	=	the given irrigated area in square feet
96.25	=	constant for conversion of area and flow into common units

Example: What is the average precipitation rate for a section of turf 325' by 80' if the total flow from all sprinklers in the area is 112 GPM.

$$Pr = \frac{96.25 \times 112}{(325 \times 80)} \qquad Pr = 0.41 \text{ in./hr.}$$

## SPRINKLER RUN TIME FORMULA

The sprinkler run time formula calculates the number of minutes required to apply enough water to replace the water lost by evapotranspiration for a specific crop irrigated with a system at a particular precipitation rate and efficiency.

$$T = \frac{60 \times D \times Et_o \times K_c}{Pr \times E_a}$$

Where:

T	=	sprinkler run time in minutes
Et <sub>o</sub>	=	reference evapotranspiration rate, in inches
K <sub>c</sub>	=	crop coefficient, percent
Pr	=	precipitation rate of the area, in inches per hour
E <sub>a</sub>	=	application efficiency of the system, percent
60	=	Constant for conversion of area, flow, inches per hour and inches per day into common units
D	=	Watering frequency in days

Example: Determine the sprinkler run time for a commercial turf site with an E<sub>to</sub> of 0.15 inches per day and a crop coefficient for the cool season turf of 0.90. The sprinkler precipitation rate is 1.50 in./hr. with an application efficiency of 65%. The watering schedule is set for every three days.

$$T = \frac{60 \times 3 \times 0.15 \times 0.90}{1.50 \times 0.65} = \frac{24.3}{.975} = 24.92 \qquad T = 25 \text{ minutes every 3 days}$$

# Hunter®

**Hunter Industries Incorporated • The Irrigation Innovators**  
1940 Diamond Street • San Marcos, California 92078 • TEL: (1) 760-744-5240 • FAX: (1) 760-744-7461  
[www.HunterIndustries.com](http://www.HunterIndustries.com)

© 2006 Hunter Industries Incorporated

LIT-323.PDF 1/06