

VOLTEX[®]

WEATHERPROOF

12
YEAR WARRANTY



- Isolating Switches
- Mounting Enclosure
- Single and Double Switches
- Single and Double Powerpoints



1300 722 275 F: 1300 738 717
www.cableloc.com

CABLE-LOC
ELECTRICAL ACCESSORIES

Weatherproof Isolating switches IP66

Weather-resistant isolator wide range of applications, suitable for any outdoor application conditions

Double Pole Isolating Switch 20A 250V 2P

International
Protection
Rating **IP66**



WPS220

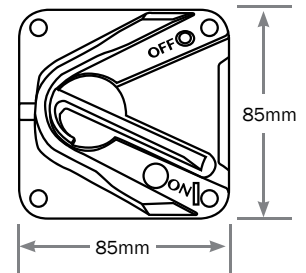
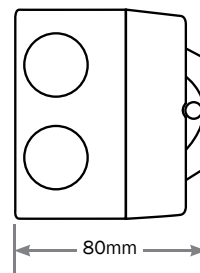

SPECIFICATIONS

20A 250V Double pole isolating switch

M100 Rating

8mm diameter locking facility

Supplied with screws and accessories

Weatherproof Isolating switches IP66

Isolating Switch

35A 250V 1P

63A 415V 3P

International Protection Rating **IP66**



35A 1P / 63A 3P



35A 1P
WPS135



63A 3P
WPS363

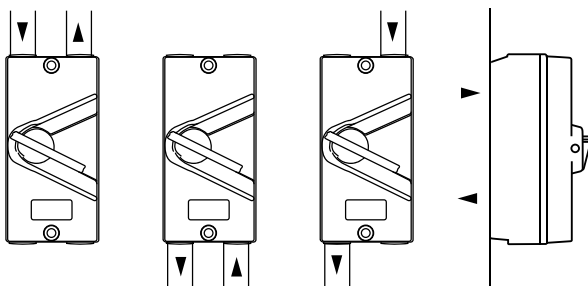
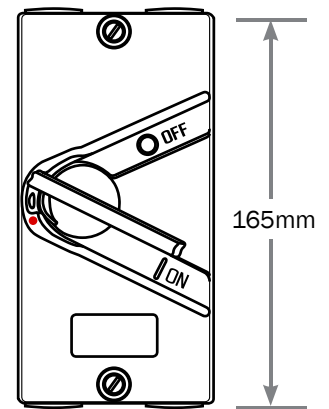
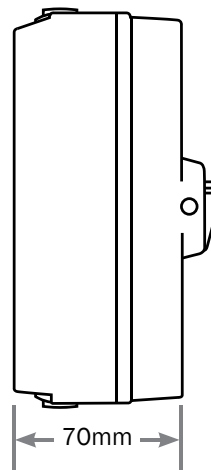

- ▶ Cables Looped in and out from overhead.
- ▶ In and out from underground.
- ▶ In and out straight through the switch.
- ▶ Two 25mm rear knockouts are moulded in the base for surface mounting with concealed wiring.

Weatherproof Single and Double switches

Weather-resistant isolator wide range of applications, suitable for any outdoor conditions

Double pole isolating switch 20A 2P



WSW1

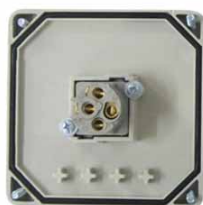

WSW2



International Protection Rating **IP56**

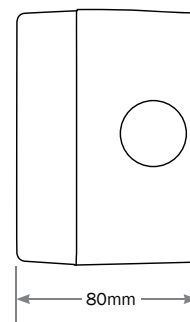
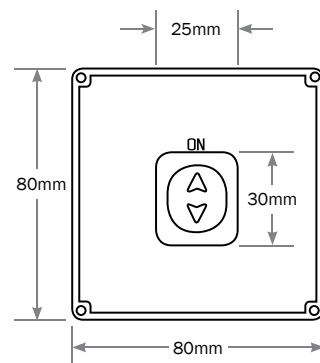

SPECIFICATIONS

Single & Double switch 20A, 1 way

250Va.c. 50Hz

Rating IP56

Supplied with screws and accessories

Weatherproof Single and Double Powerpoints (Old style)

Weather-resistant powerpoints wide range of applications, suitable for any outdoor conditions

International Protection Rating **IP53**

Single Powerpoint (Old Style)

Double Powerpoint (Old Style)



Rating	Product Code
10A	WPP1H0



Rating	Product Code
10A	WPP2H0
15A	WPP2H-15



SPECIFICATIONS

IP53 rated 10 or 15Amp weatherproof single & double socket outlet.

Complete with mounting block.8mm diameter locking facility

Made from quality fire resistant and UV stable material.

20mm & 25mm conduit entry locations.

Carton Qty: 45

Weatherproof Single and Double Powerpoints

Weather-resistant powerpoints wide range of applications, suitable for any outdoor conditions

International Protection Rating **IP53**

Single Powerpoint



Rating	Product Code
10A	WPP1H
15A	WPP1H-15

Double Powerpoint



Rating	Product Code
10A	WPP2H
15A	WPP2H-15

Double Powerpoint Slimline



Rating	Product Code
10A	WPP2HS

SPECIFICATIONS

Complete with mounting block.8mm diameter locking facility

Made from quality fire resistant and UV stable material.

20mm & 25mm conduit entry locations.

Weatherproof Mounting Enclosures

Weatherproof enclosure with clear lid and locking provision.



Product Code: V255

International
Protection
Rating **IP53**



SPECIFICATIONS

IP53 rated product

Split Quantity: 1

Carton Qty: 30

Dimensions: 135mm (W) x 100mm (H)
80mm (D)